

T-1₁

Name: _____

Student code: _____

5 pts

marks

25

75

1-1.

The mass of a water droplet:

$$m = V \rho = [(4/3) \pi r^3] \rho = (4/3) \pi (0.5 \times 10^{-6} \text{ m})^3 (1.0 \text{ g/cm}^3) \\ = 5.2 \times 10^{-16} \text{ kg} \quad \Rightarrow \quad \mathbf{10 \text{ marks}}$$

Average kinetic energy at 27°C:

$$\text{KE} = mv^2/2 = (5.2 \times 10^{-16} \text{ kg}) (0.51 \times 10^{-2} \text{ m/s})^2/2 \\ = 6.9 \times 10^{-21} \text{ kg m}^2/\text{s}^2 = \underline{\mathbf{6.9 \times 10^{-21} \text{ J}}} \quad \Rightarrow \quad \mathbf{15 \text{ marks}}$$

1-2.

The average kinetic energy of an argon atom is the same as that of a water droplet.

KE becomes zero at -273 °C.

From the linear relationship in the figure, $\text{KE} = aT$ (absolute temperature)where a is the increase in kinetic energy of an argon atom per degree.

$$a = \text{KE}/T = 6.9 \times 10^{-21} \text{ J}/(27+273\text{K}) = 2.3 \times 10^{-23} \text{ J/K} \quad \Rightarrow \quad \mathbf{25 \text{ marks}}$$

S: specific heat of argon N: number of atoms in 1g of argon

$$S = 0.31 \text{ J/g K} = a \times N$$

$$N = S/a = (0.31 \text{ J/g K}) / (2.3 \times 10^{-23} \text{ J/K})$$

$$= 1.4 \times 10^{22} \quad \Rightarrow \quad \mathbf{30 \text{ marks}}$$

Avogadro's number (N_A) : Number of argon atoms in 40 g of argon

$$N_A = (40)(1.4 \times 10^{22})$$

$$= \underline{\mathbf{5.6 \times 10^{23}}} \quad \Rightarrow \quad \mathbf{20 \text{ marks}}$$

T-2₁

Name: _____

Student code: _____

5 pts

marks

30

30

10

20

10

2-1.

$$\begin{aligned} \text{mass of a typical star} &= (4/3)(3.1)(7 \times 10^8 \text{ m})^3 (1.4 \text{ g}/10^{-6} \text{ m}^3) = 2 \times 10^{33} \text{ g} \\ \text{mass of protons of a typical star} &= (2 \times 10^{33} \text{ g})(3/4 + 1/8) = 1.8 \times 10^{33} \text{ g} \\ \text{number of protons of a typical star} &= (1.8 \times 10^{33} \text{ g})(6 \times 10^{23} / \text{g}) = 1 \times 10^{57} \\ \text{number of stellar protons in the universe} &= (1 \times 10^{57})(10^{23}) = \underline{1 \times 10^{80}} \end{aligned} \Rightarrow \text{30 marks}$$

Partial credits on principles:**Volume = (4/3)(3.14)radius³×density; 4 marks****1 mole = 6×10²³; 4 marks****Total number of protons in the universe = number of protons in a star ×10²³; 2 marks****Mass fraction of protons from hydrogen = (3/4)(1/1); 5 marks****Mass fraction of protons from helium = (1/4)(2/4); 10 marks****2-2.**

$$\begin{aligned} \Delta E(2 \rightarrow 3) &= C(1/4 - 1/9) = 0.1389 C & \lambda(2 \rightarrow 3) &= 656.3 \text{ nm} \\ \Delta E(1 \rightarrow 2) &= C(1/1 - 1/4) = 0.75 C \\ \lambda(1 \rightarrow 2) &= (656.3)(0.1389/0.75) = 121.5 \text{ nm} \end{aligned} \Rightarrow \text{30 marks}$$

No penalty for using Rydberg constant from memory.**15 marks penalty if answered in a different unit (Hz, etc.)****2-3.**

$$T = (2.9 \times 10^{-3} \text{ m K}) / 1.215 \times 10^{-7} \text{ m} = 2.4 \times 10^4 \text{ K} \Rightarrow \text{10 marks}$$

2-4. .

$$\begin{aligned} \lambda &= 3 \times 10^8 \text{ m} / 1.42 \times 10^9 = 0.21 \text{ m} \\ T &= (2.9 \times 10^{-3} \text{ m K}) / 0.21 \text{ m} = 0.014 \text{ K} \end{aligned} \Rightarrow \text{20 marks}$$

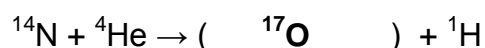
2-5.**O-17, ${}^{17}_8\text{O}$ acceptable**

T-3₁

Name: _____

Student code: _____

5 pts

marks

30

30

25

15

3-1.

$$k_{\text{des}} = A \exp(-E_{\text{des}}/RT)$$

$$= (1 \times 10^{12} \text{ s}^{-1})(5 \times 10^{-32}) = 5 \times 10^{-20} \text{ s}^{-1} \text{ at } T = 20 \text{ K} \quad \Rightarrow \quad \mathbf{10 \text{ marks}}$$

$$\text{surface residence time, } \tau_{\text{residence}} = 1 / k_{\text{des}} = 2 \times 10^{19} \text{ s} = \underline{6 \times 10^{11} \text{ yr}} \quad \Rightarrow \quad \mathbf{20 \text{ marks}}$$

$$(\text{full credit for } \tau_{\text{half-life}} = \ln 2 / k_{\text{des}} = 1 \times 10^{19} \text{ s} = 4 \times 10^{11} \text{ yr})$$

$$\text{residence time} = \mathbf{2 \times 10^{19} \text{ s}}$$

3-2.The distance to be traveled by a molecule: $x = \pi r = 300 \text{ nm}$.

$$k_{\text{mig}} = A \exp(-E_{\text{mig}}/RT)$$

$$= (1 \times 10^{12} \text{ s}^{-1})(2 \times 10^{-16}) = 2 \times 10^{-4} \text{ s}^{-1} \text{ at } T = 20 \text{ K} \quad \Rightarrow \quad \mathbf{5 \text{ marks}}$$

average time between migratory jumps, $\tau = 1 / k_{\text{mig}} = 5 \times 10^3 \text{ s}$

the time needed to move 300 nm

$$= (300 \text{ nm} / 0.3 \text{ nm}) \text{ jumps} \times (5 \times 10^3 \text{ s/jump}) = 5 \times 10^6 \text{ s} = \underline{50 \text{ days}} \quad \Rightarrow \quad \mathbf{15 \text{ marks}}$$

(Full credit for the calculation using a random-walk model. In this case:

$$t = \tau (x/d)^2 = 5 \times 10^9 \text{ s} = 160 \text{ yr. The answer is still (b).)$$

(a) **(b)** (c) (d) (e) **10 marks****3-3.**

$$k(20 \text{ K}) / k(300 \text{ K}) = \exp[(E/R) (1/T_1 - 1/T_2)]$$

$$= e^{-112} = \sim 10^{-49} \text{ for the given reaction .) } \quad \Rightarrow \quad \mathbf{15 \text{ marks}}$$

The rate of formaldehyde production at 20 K

$$= \sim 10^{-49} \text{ molecule/site/s} = \sim 10^{-42} \text{ molecule/site/yr}$$

 \Rightarrow **10 marks**(The reaction will not occur at all during the age of the universe ($1 \times 10^{10} \text{ yr}$.)

$$\text{rate} = \mathbf{10^{-42} \text{ molecules/site/yr}}$$

3-4. circle one(a) (b) (c) (a, b) (a, c) **(b, c)** (a, b, c)**(15 marks, all or nothing)**

T-4₁

Name: _____

Student code: _____

5 pts

marks

20

20

20

20

4-1.

Number of atoms	H (11.3)	P 1	⇒	10 marks
Theoretical wt %	(3.43)		⇒	10 marks

4-2.

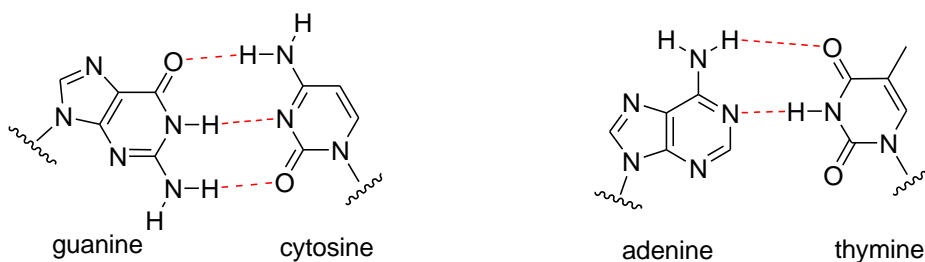

(10 marks on each)

4-3. 7 marks each, 20 marks for three

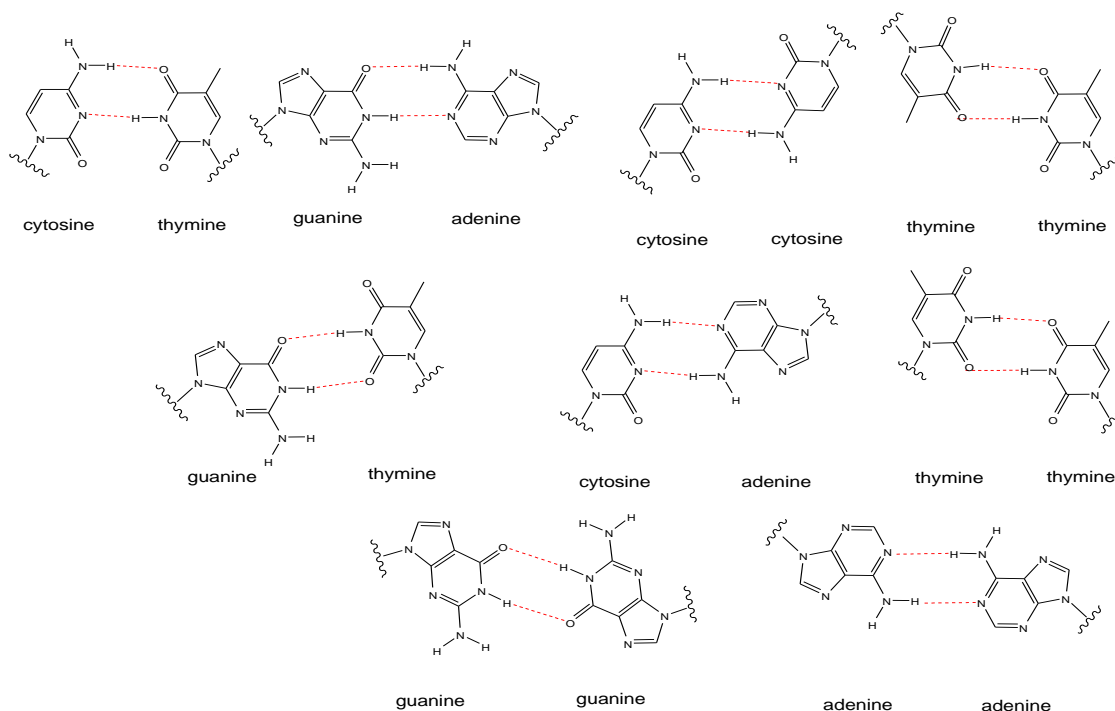

4-4. 2.5 marks for each bracket

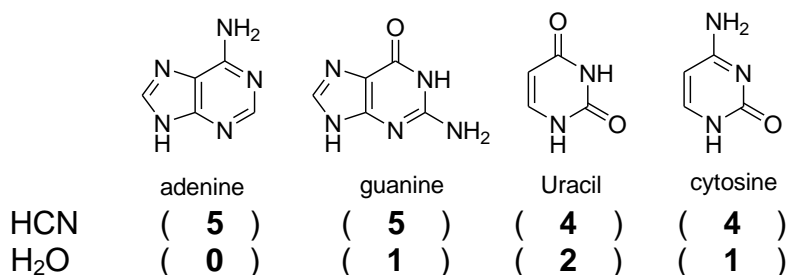

T-5₁

Name: _____

Student code: _____

5 pts**marks****20****20****20****5-1. (20 marks)**1st ionization is complete: $\text{H}_2\text{SO}_4 \rightarrow \text{H}^+ + \text{HSO}_4^-$

$$[\text{H}_2\text{SO}_4] = 0$$

2nd ionization: $[\text{H}^+][\text{SO}_4^{2-}]/[\text{HSO}_4^-] = K_2 = 1.2 \times 10^{-2}$ (1)

Mass balance: $[\text{H}_2\text{SO}_4] + [\text{HSO}_4^-] + [\text{SO}_4^{2-}] = 1.0 \times 10^{-7}$ (2)

Charge balance: $[\text{H}^+] = [\text{HSO}_4^-] + 2[\text{SO}_4^{2-}] + [\text{OH}^-]$ (3)

Degree of ionization is increased upon dilution.

$$[\text{H}_2\text{SO}_4] = 0$$

Assume $[\text{H}^+]_{\text{H}_2\text{SO}_4} = 2 \times 10^{-7}$

From (1), $[\text{SO}_4^{2-}]/[\text{HSO}_4^-] = 6 \times 10^4$ (2nd ionization is almost complete)

$$[\text{HSO}_4^-] = 0$$

From (2), $[\text{SO}_4^{2-}] = 1.0 \times 10^{-7}$ [5 marks]

From (3), $[\text{H}^+] = (2 \times 10^{-7}) + 10^{-14}/[\text{H}^+]$

$$[\text{H}^+] = 2.4 \times 10^{-7} \quad (\text{pH} = 6.6) \text{ [8 marks]}$$

$$[\text{OH}^-] = 10^{-14}/(2.4 \times 10^{-7}) = 4.1 \times 10^{-8} \text{ [2 marks]}$$

From (1), $[\text{HSO}_4^-] = [\text{H}^+][\text{SO}_4^{2-}]/K_2$

$$= (2.4 \times 10^{-7})(1.0 \times 10^{-7})/(1.2 \times 10^{-2}) = 2.0 \times 10^{-12} \text{ [5 marks]}$$

Check charge balance:

$$2.4 \times 10^{-7} \approx (2.0 \times 10^{-12}) + 2(1.0 \times 10^{-7}) + (4.1 \times 10^{-8})$$

Check mass balance:

$$0 + 2.0 \times 10^{-12} + 1.0 \times 10^{-7} \approx 1.0 \times 10^{-7}$$

Species	Concentration
HSO_4^-	2.0×10^{-12}
SO_4^{2-}	1.0×10^{-7}
H^+	2.4×10^{-7}
OH^-	4.1×10^{-8}

T-5₂

Name: _____

Student code: _____

5-2. (20 marks)

mmol $\text{H}_3\text{PO}_4 = 0.85 \times 3.48 \text{ mL} \times 1.69\text{g/mL} \times 1 \text{ mol}/98.00 \text{ g} \times 1000 = 51.0$ [5 marks]

The desired pH is above pK_2 .

A 1:1 mixture of H_2PO_4^- and HPO_4^{2-} would have $\text{pH} = pK_2 = 7.20$.

If the pH is to be 7.40, there must be more HPO_4^{2-} than H_2PO_4^- .

We need to add NaOH to convert H_3PO_4 to H_2PO_4^- and to convert to the right amount of H_2PO_4^- to HPO_4^{2-} .

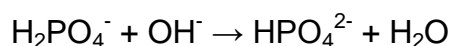
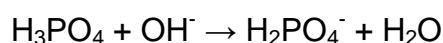

The volume of 0.80 NaOH needed to react with to to convert H_3PO_4 to H_2PO_4^- is:

$$51.0 \text{ mmol} / 0.80\text{M} = 63.75 \text{ mL} \quad [5 \text{ marks}]$$

To get pH of 7.40 we need:

	$\text{H}_2\text{PO}_4^- + \text{OH}^- \rightarrow \text{HPO}_4^{2-}$		
Initial mmol	51.0	x	0
Final mmol	51.0-x	0	x

$$\text{pH} = pK_2 + \log [\text{HPO}_4^{2-}] / [\text{H}_2\text{PO}_4^-]$$

$$7.40 = 7.20 + \log \{x / (51.0-x)\}; x = 31.27 \text{ mmol} \quad [5 \text{ marks}]$$

The volume of NaOH needed to convert 31.27 mmol is :

$$31.27 \text{ mmol} / 0.80 \text{ M} = 39.09 \text{ mL}$$

The total volume of NaOH = 63.75 + 39.09 = 102.84 mL , 103 mL [5 marks]

Total volume of 0.80 M NaOH (mL)**103 mL**

T-5₃

Name: _____

Student code: _____

5-3. (20 marks)

$$pK = 3.52$$

$$pH = pK_a + \log ([A^-]/[HA])$$

$$[A^-]/[HA] = 10^{(pH-pK_a)} \quad [5 \text{ marks}]$$

$$\text{In blood, } pH = 7.40, [A^-]/[HA] = 10^{(7.40-3.52)} = 7586$$

$$\text{Total ASA} = 7586 + 1 = 7587 \quad [5 \text{ marks}]$$

$$\text{In stomach, } pH = 2.00, [A^-]/[HA] = 10^{(2.00-3.52)} = 3.02 \times 10^{-2}$$

$$\text{Total ASA} = 1 + 3.02 \times 10^{-2} = 1.03 \quad [5 \text{ marks}]$$

$$\text{Ratio of total aspirin in blood to that in stomach} = 7587/1.03 = \underline{7400} \quad [5 \text{ marks}]$$

Ratio of total aspirin in blood to that in stomach **7.4×10^3**

T-6₁

Name: _____

Student code: _____

5 pts**marks**

5

5

5

20

15

15

10

10

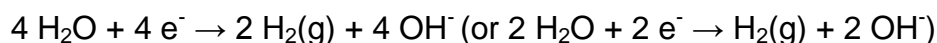
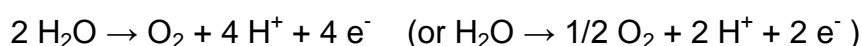
6-1. (5 marks)**6-2. (5 marks)****6-3. (5 marks)****6-4. (20 marks)**

Reduction of sodium ion seldom takes place.

It has a highly negative reduction potential of -2.710 V .

Reduction potential for water to hydrogen is negative (water is very stable).

But, it is not as negative as that for sodium ion. It is -0.830 V .

Reduction of both copper ion and oxygen takes place readily and the reduction potentials for both are positive.

In the present system, the reverse reaction (oxidation) takes place at the positive terminal. Copper is oxidized before water.

Reduction potential for hydrogen ion is defined as 0.000 V .

Reduction of oxygen	_____	-2.710
Reduction of water	_____	-0.830
Reduction of sodium ion (Na^+)	_____	0.000
Reduction of hydrogen ion	_____	+1.230

6-5. (15 marks)

$$\text{pOH} = 14.00 - 4.84 = 9.16$$

$$[\text{OH}^-] = 6.92 \times 10^{-10}$$

$$K_{\text{sp}} = [\text{Cu}^{2+}][\text{OH}^-]^2 = 0.100 \times (6.92 \times 10^{-10})^2 = 4.79 \times 10^{-20}$$

T-6₂

Name: _____

Student code: _____

6-6.

$$\begin{aligned}
 E &= E^{\circ}_{\text{Cu}^{2+}/\text{Cu}} + (0.0592/2) \log [\text{Cu}^{2+}] \\
 &= +0.340 + (0.0592/2) \log [\text{Cu}^{2+}] \\
 &= +0.340 + (0.0592/2) \log (K_{\text{sp}} / [\text{OH}^-]^2) \\
 &= +0.340 + (0.0592/2) \log (K_{\text{sp}}) - (0.0592/2) \log [\text{OH}^-]^2 \\
 &= +0.340 + (0.0592/2) \log (K_{\text{sp}}) - 0.0592 \log [\text{OH}^-],
 \end{aligned}$$

3 marks

By definition, the standard potential for $\text{Cu}(\text{OH})_2(\text{s}) + 2\text{e}^- \rightarrow \text{Cu}(\text{s}) + 2\text{OH}^-$ is the potential where $[\text{OH}^-] = 1.00$.

$$\begin{aligned}
 E &= E^{\circ}_{\text{Cu}(\text{OH})_2/\text{Cu}} = +0.340 + (0.0592/2) \log (K_{\text{sp}}) \\
 &= +0.340 + (0.0592/2) \log (4.79 \times 10^{-20}) \\
 &= +0.340 - 0.572 \\
 &= -0.232 \text{ V}
 \end{aligned}$$

2 marks**10 marks**

One may solve this problem as following.

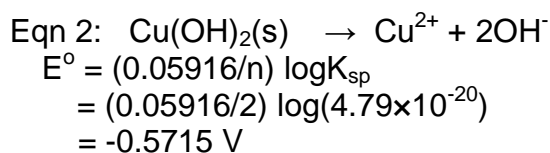
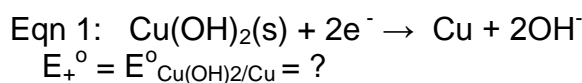
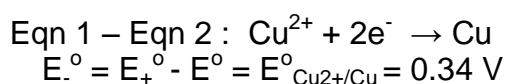
**3 marks**

Therefore, $E^{\circ}_+ = E^{\circ} + E^{\circ} = +0.34 + (-0.5715)$

2 marks

$= -0.232 \text{ V}$

10 marks**-0.232 V****6-7.**

Below pH = 4.84, there is no effect of $\text{Cu}(\text{OH})_2$ because of no precipitation.

Therefore,

$$\begin{aligned}
 E &= E_{\text{Cu}^{2+}/\text{Cu}} = +0.340 + (0.0592/2) \log [\text{Cu}^{2+}] \\
 &= +0.340 + (0.0592/2) \log 0.100 \\
 &= +0.340 - 0.0296 = +0.310 \text{ V}
 \end{aligned}$$

3 marks**7 marks****0.310 V**

T-6₃

Name: _____

Student code: _____

6-8.

1.00 g graphite = 0.0833 mol carbon

6 mol carbon to 1 mol lithium; 1 g graphite can hold 0.0139 mol lithium

To insert 1 mol lithium, 96487 coulombs are needed.

Therefore, 1 g graphite can charge $96487 \times 0.0139 = 1340$ coulombs. **5 marks** $1340 \text{ coulombs / g} = 1340 \text{ A sec / g} = 1340 \times 1000 \text{ mA} \times (1 / 3600) \text{ h} = 372 \text{ mA h / g}$ **5 marks****372 mA h / g**

T-7₁	Name: _____	4 pts		
	Student code: _____	marks		
		10	20	50

7-1. (10 marks)

$$n/V = P/RT = (80 \times 10^6 / 1.013 \times 10^5 \text{ atm}) / [(0.082 \text{ atm L/mol/K})(298\text{K})] = 32 \text{ mol/L}$$

5 marks

$$\text{density} = \text{mass/volume} = d = 32 \times 2 \text{ g/L} = 64 \text{ kg/m}^3$$

5 marks

64 kg/m³

7-2.

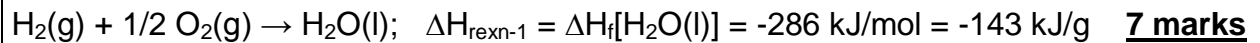

$$(-\Delta H_{\text{rexn-1}}) / (-\Delta H_{\text{rexn-2}}) = 4.3 \quad \text{or} \quad (-\Delta H_{\text{rexn-2}}) / (-\Delta H_{\text{rexn-1}}) = 0.23$$

6 marks

4.3 or 0.23

7-3.

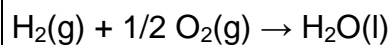

$$\Delta H_c = -286 \text{ kJ/mol} = -143 \text{ kJ/g} = -143 \times 10^3 \text{ kJ/kg}$$

5 marks

$$\Delta G = \Delta H - T\Delta S$$

$$\Delta S_c = 70 - 131 - 205/2 = -163.5 \text{ J/K/mol}$$

5 marks

$$\Delta G_c = -286 \text{ kJ/mol} + 298\text{K} \times 163.5 \text{ J/K/mol} = -237 \text{ kJ/mol} = -1.2 \times 10^5 \text{ kJ/kg}$$

5 marks

(a) electric motor $W_{\text{max}} = \Delta G_c \times 1 \text{ kg} = -1.2 \times 10^5 \text{ kJ}$

5 marks

(b) heat engine $W_{\text{max}} = \text{efficiency} \times \Delta H_c$
 $= (1 - 298/573) \times (-143 \times 10^3 \text{ kJ}) = -6.9 \times 10^4 \text{ kJ}$

5 marks

5 marks

$$119 \times 10^3 \text{ kJ} = 1 \text{ W} \times t(\text{sec})$$

$$t = 1.2 \times 10^8 \text{ sec} = 3.3 \times 10^4 \text{ hr} = 1.4 \times 10^3 \text{ days} = 46 \text{ month} = 3.8 \text{ yr}$$

5 marks

$$\Delta G = -nFE \quad n = \# \text{ of electrons involved in the reaction}$$

$$F = 96.5 \text{ kC/mol}$$

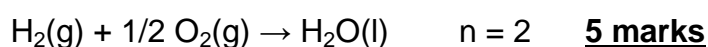

$$E = -\Delta G/nF = 237 \text{ kJ/mol} / 2 / 96.5 \text{ kC/mol} = 1.23 \text{ V}$$

5 marks

$$I = W/E = 0.81 \text{ A}$$

5 marks

(a) $(-1.2 \times 10^5 \text{ kJ})$, (b) $(-6.9 \times 10^4 \text{ kJ})$
1.2 x 10 ⁸ sec or 3.3 x 10 ⁴ hr or 1.4 x 10 ³ days or 46 month or 3.8 yr
I = 0.81 A

T-8₁	Name: _____	5 pts				
	Student code: _____	marks				
		15	25	20	20	20

8-1-1. (5 marks on each)

① C	② C	③ CO
-----	-----	------

8-1-2.

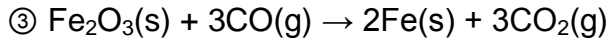

From ① and ②,

$$\Delta H_f^\circ(\text{CO}(\text{g})) = (1/2)\{172.46 + (-393.51)\} = -110.525 \text{ kJ}$$

$$\Delta H_f^\circ(\text{Fe}_2\text{O}_3) = -824.2 \text{ kJ}$$

$$\Delta H_{\text{③}}^\circ = 3 \times \Delta H_f^\circ(\text{CO}_2(\text{g})) - \Delta H_f^\circ(\text{Fe}_2\text{O}_3) - 3 \times \Delta H_f^\circ(\text{CO}(\text{g}))$$

$$= 3 \times (-393.51) - (-824.2) - 3 \times (-110.525) = -24.8 \text{ kJ} \quad \text{7 marks}$$

$$\Delta S_{\text{③}}^\circ = 2 \times 27.28 + 3 \times 213.74 - 87.4 - 3 \times 197.674 = 15.36 \text{ J/K} \quad \text{3 marks}$$

$$\Delta G_{\text{③}}^\circ = \Delta H^\circ - T \Delta S^\circ = -24.8 \text{ kJ} - 15.36 \text{ J/K} \times 1 \text{ kJ} / 1000 \text{ J} \times 1473.15 \text{ K} = -47.43 \text{ kJ}$$

$$K = e^{(-\Delta G^\circ / RT)} = e^{(47430 \text{ J} / (8.314 \text{ J/K} \times 1473.15 \text{ K}))} = 48 \quad \begin{array}{l} \text{5 marks} \\ \text{5 marks} \end{array}$$

Balanced equation of ③: $\text{Fe}_2\text{O}_3(\text{s}) + 3\text{CO}(\text{g}) \rightarrow 2\text{Fe}(\text{s}) + 3\text{CO}_2(\text{g})$	K = 48
--	---------------

8-2-1. (20 marks)

One AB_2O_4 unit has available 4 (= 1 + (1/4) × 12) octahedral sites.

4

8-2-2. (20 marks)

Since one face-centered cube in AB_2O_4 represents one Fe_3O_4 unit in this case, it has 8 available tetrahedral sites. In one Fe_3O_4 unit, 1 tetrahedral site should be occupied by either one Fe^{2+} (normal-spinel) or one Fe^{3+} (inverse-spinel). Therefore, in both cases, the calculation gives (1/8) × 100% = 12.5% occupancy in available tetrahedral sites.

12.5%

8-2-3. (10 marks for d-orbital splitting, 10 marks for elec. distribution)

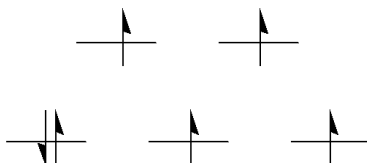

T-9₁

Name: _____

Student code: _____

5 pts

marks

15

10

20

15

10

40

10

9-1-1.

1 answer for 8 marks, two for 15 marks

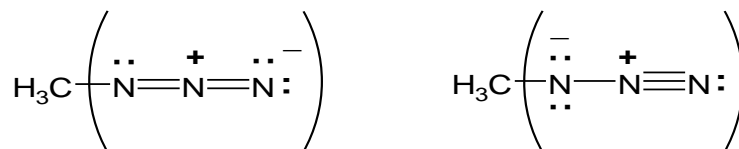

9-1-2.

(10 marks)

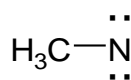

9-1-3.

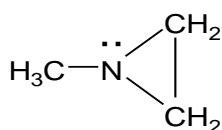

(10 marks)

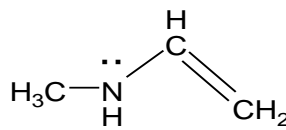

(10 marks)

9-2-1.

5 marks each

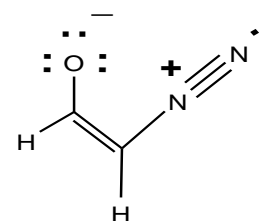
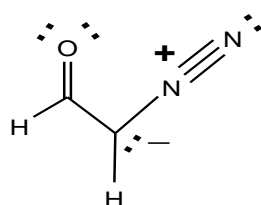
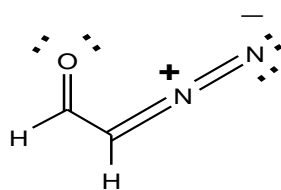

T-9₂

Name: _____

Student code: _____

9-2-2.

(10 marks)

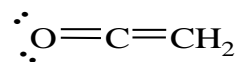

9-3-1.

(40 marks)

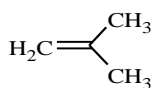
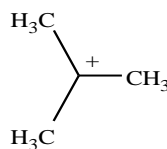
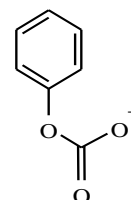
**B****C****D****E**

9-3-2.

(10 marks)

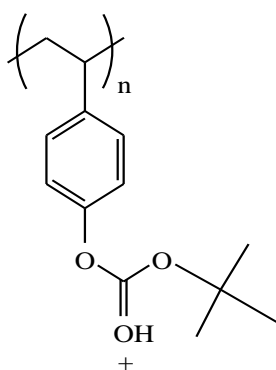
**F**

T-10₁

Name: _____

Student code: _____

9 pts

marks

30

20

20

10

30

20

10-1.

10 marks each

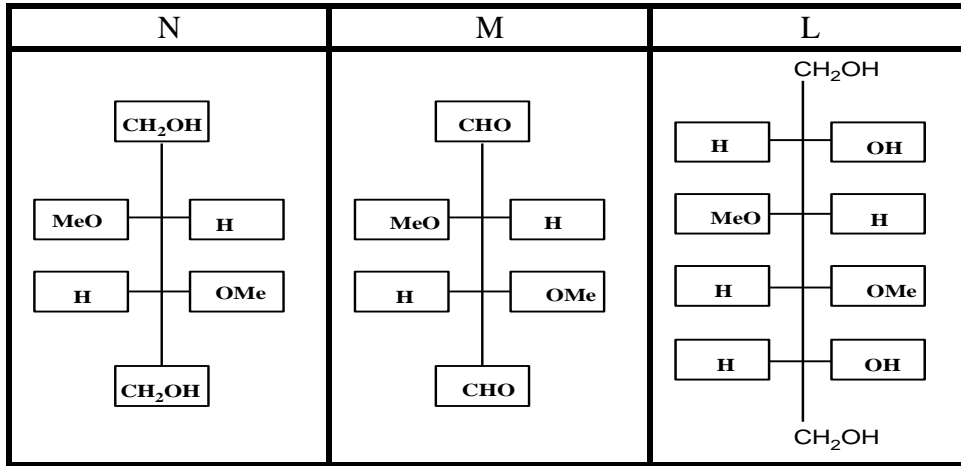

10-2.

8 marks each for correct structures

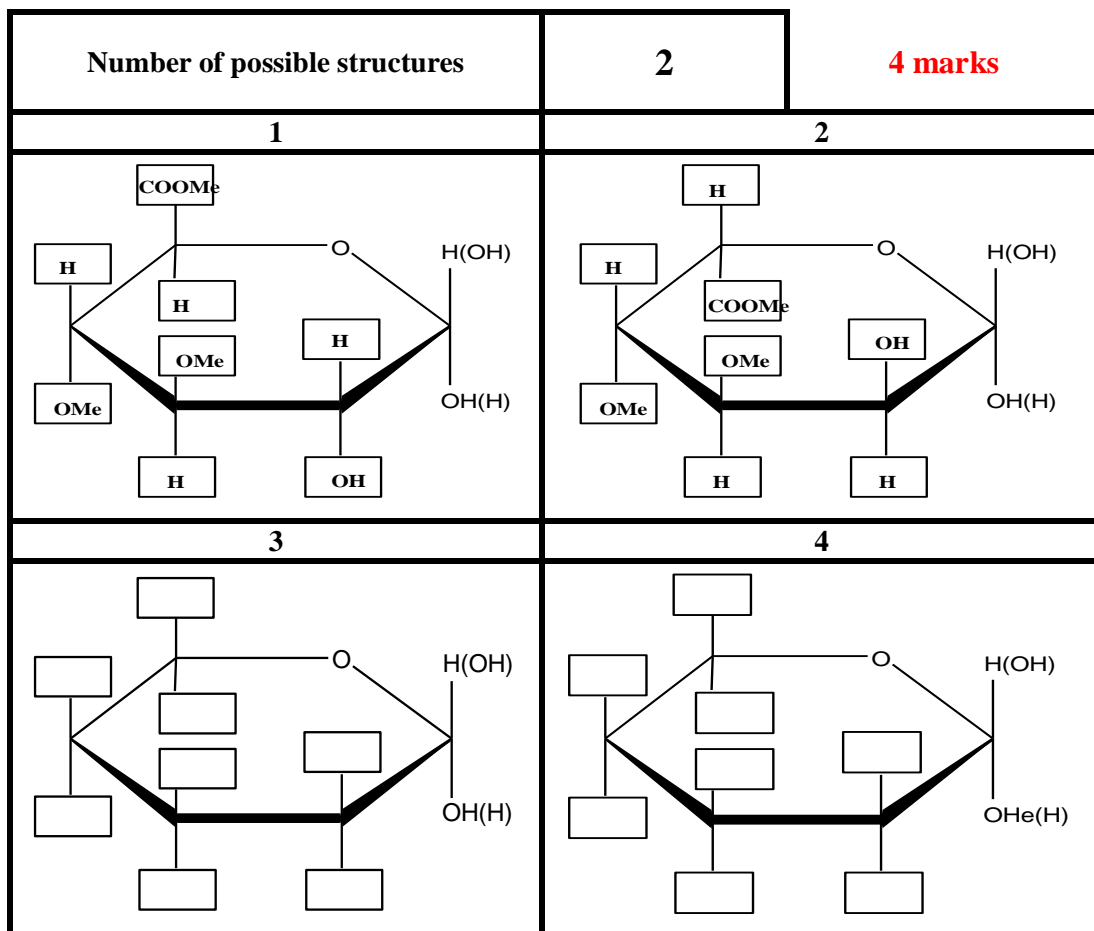

T-10₂

Name: _____

Student code: _____

10-3.

10 marks each

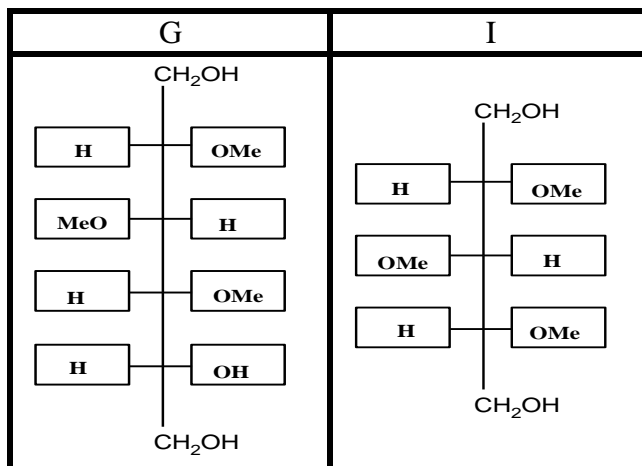

10-4.

10 marks

Number of the correct structure for C from 10-2

1

10-5.

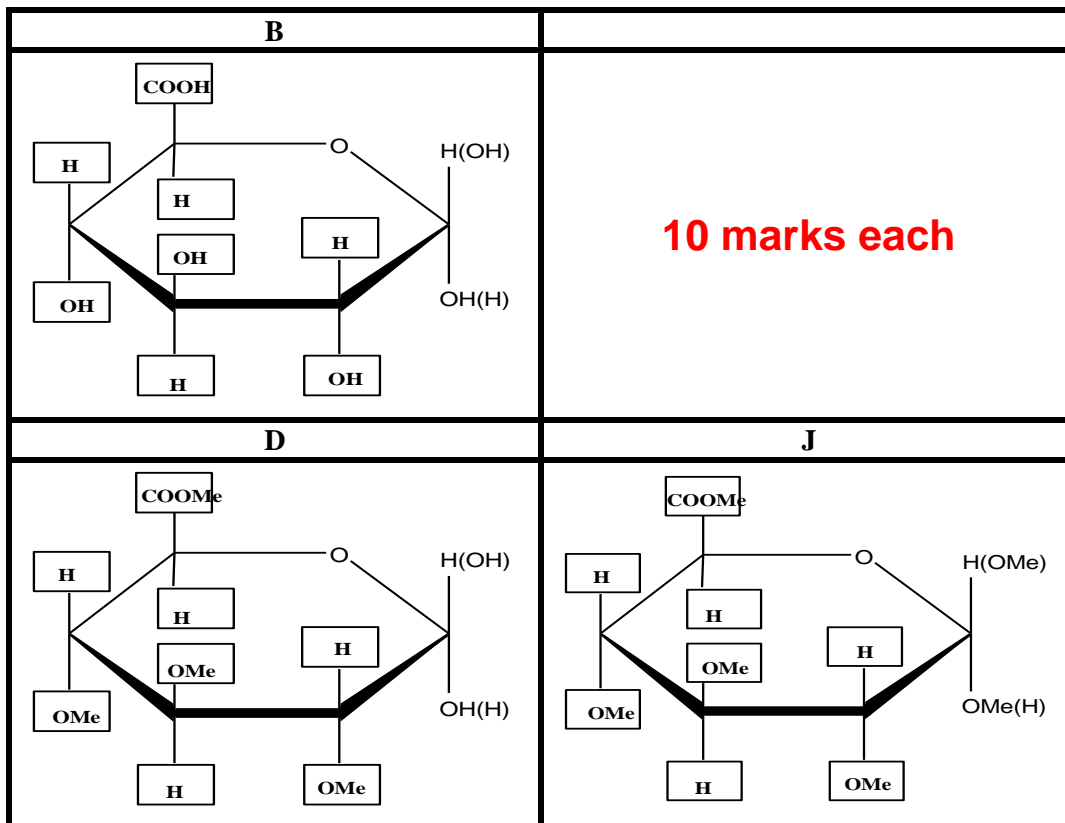

T-10₃

Name: _____

Student code: _____

10-6.

20 marks

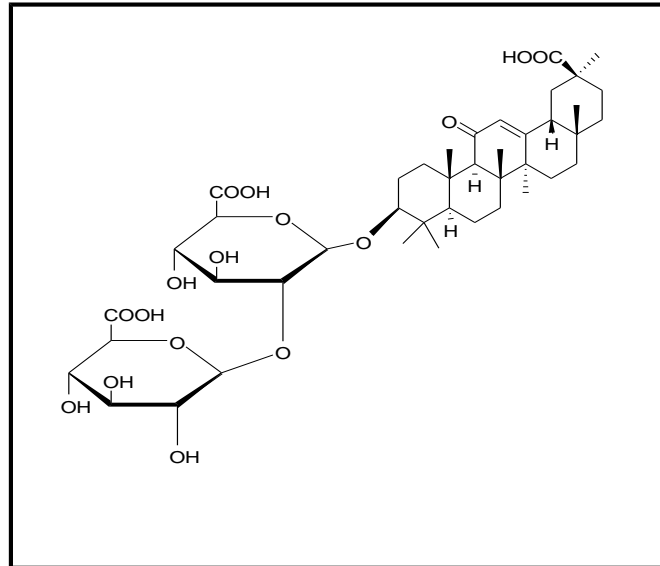

T-11₁

Name: _____

Student code: _____

7pts

marks

10

30

10

20

30

11-1. 10 marks

3

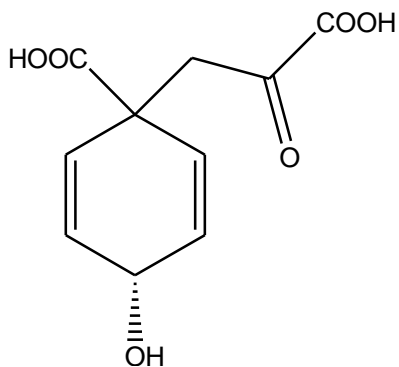
11-2. 30 marks**11-3. 2.5 marks each**

a, c, d

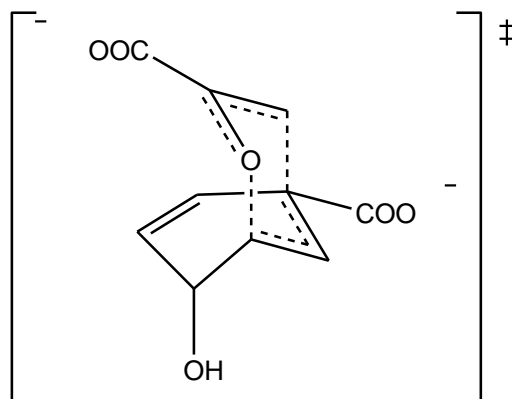
11-4 30 marks

Transition State

T-11₂

Name: _____

Student code: _____

11-5.

For the enzyme-catalyzed reaction, Arrhenius equation could be applied.

$$k_{\text{cat}}/k_{\text{uncat}} = A \exp(-E_{a, \text{cat}}/RT) / A \exp(-E_{a, \text{uncat}}/RT)$$

$$= \exp[-\Delta E_{a, \text{cat-uncat}}/RT]$$

$$= \exp[-\Delta E_{a, \text{cat-uncat}}(\text{J/mol}) / (2,480 \text{ J/mol})] = 10^6$$

$$\text{Therefore, } -\Delta E_{a, \text{cat-uncat}} = 34,300 \text{ J/mol}$$

15 marks

$$k_{\text{uncat}, T}/k_{\text{uncat}, 298} = \exp(-\Delta H^{\ddagger}_{\text{uncat}}/RT) / \exp(-\Delta H^{\ddagger}_{\text{uncat}}/298R)$$

$$= \exp[(-\Delta H^{\ddagger}_{\text{uncat}}/R)(1/T-1/298)]$$

$$\ln(k_{\text{uncat}, T}/k_{\text{uncat}, 298}) = 13.8 = [(-86900/8.32)(1/T-1/298)]$$

$$\text{Therefore, } T = 491 \text{ K, or } 218^{\circ}\text{C}$$

15 marks

$$-E_{a, \text{cat-uncat}} = 34,300 \text{ J/mol}$$

$$T = 491 \text{ K, or } 218^{\circ}\text{C}$$